

150 AET

New serie

- Working height : 15 m
- Maximum offset : 9.10 m
- Rotation : 350°
- 250 kg including 2 people
- Electric drive : 48 v - 450 Ah
- Only 1.5 m chassis width













MANIACCESS



150 AET

New serie

-  Load capacity250 kg incl. 2 people
-  Working height15 m
Platform height.....13 m
-  Overall length5.60 m
Overall width1.50 m
Overall height1.95 m
Basket size1,2 x 0,8 m
Max.offset.....9.10 m
up and over clearance 5 m
Ground clearance.....15 cm
Turning radius ins/outside.....1,5/3,6 m
-  Travel speed 0 to 3,3 km/h
Number of speeds.....2
-  Basket rotation180°
Turret rotation350°
-  Traction battery48 V - 450 Ah
Integrated charger220 V - 50 A
-  Gradeability25%
Max. slope accepted..... 3° or 5%
-  Hydraulic tank18 l.
-  Tyres (solid)27-10 x 12
Inside and outside use wind 45 km/h
Steering.....2 wheel steer
-  Weight.....7040 kg

Standard equipment

- Oscilating steering axle
- Max. travel speed up to 1,5 m platform height
- Negative brake
- Steel basket with mesh floor
- Protected upper control box with double joystick
- Lifting brackets
- Flashing beacon
- Hour meter
- Warning buzzer in the basket
- 220 v auxiliary cable
- Low voltage indicator

Options

- Working light
- All motion alarm
- Non marking tyres

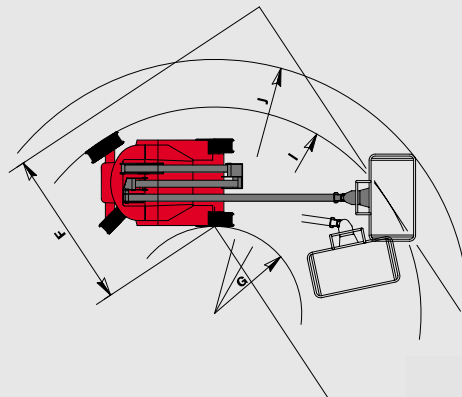
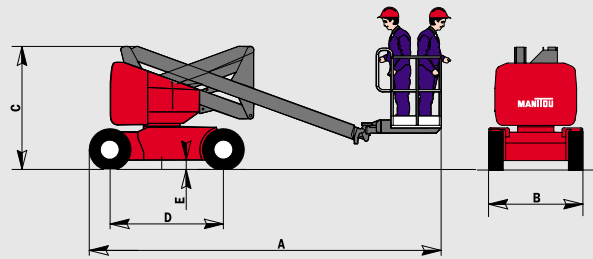
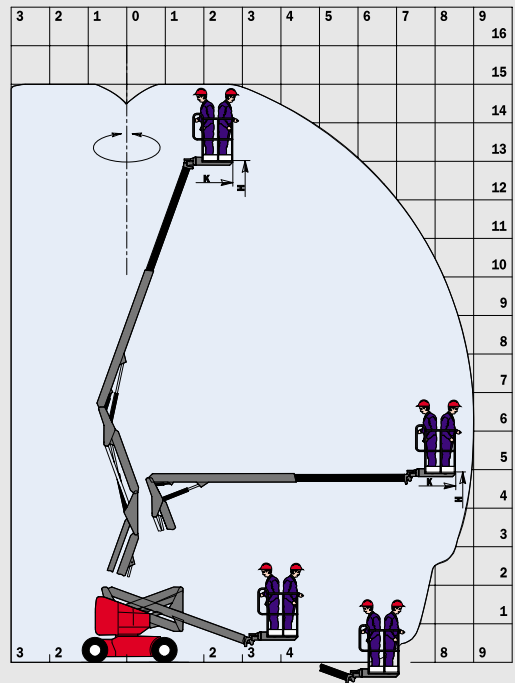

A	5600
B	1500
C	1950
D	1800
E	150
F	2727
G	1500
I	3600
J	4375

mm



This publication in no way constitutes an offer and the company reserves the right to alter specification without prior notice.



115/03/2002



MANITOU B.F. S.A.
B.P. 249 - 44158 ANCENIS CEDEX - FRANCE
TEL : 33 2 40 09 10 11
EXPORT DEPARTMENT FAX : 33 2 40 09 10 97
www.manitou.fr